

P1:

Installation simple / Eenvoudige installatie / Single installation / Einfache Installation

P2 :

Installation en série / Installatie in serie / Serial installation / Serielle Installation

FR

Lire attentivement les instructions avant de commencer le montage.

GB

Please read the instructions carefully before commencing assembly.

NL

Gelieve de instructies zorgvuldig te lezen voordat u met de installatie begint.

DE

Lesen Sie bitte die Anweisungen sorgfältig durch, bevor Sie mit dem Zusammenbauen.

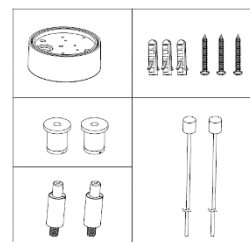
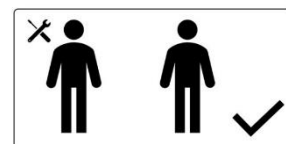
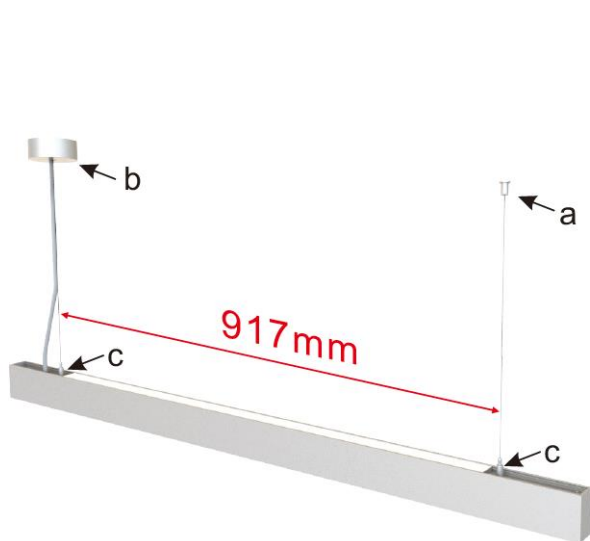

1 - Installation simple / Eenvoudige installatie / Single installation / Einfache Installation

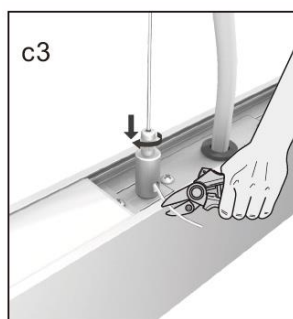
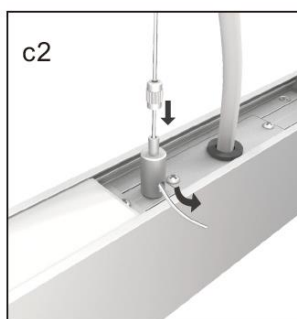
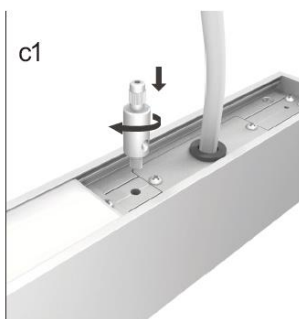
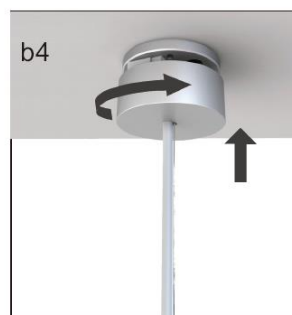
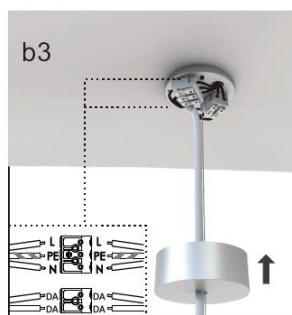
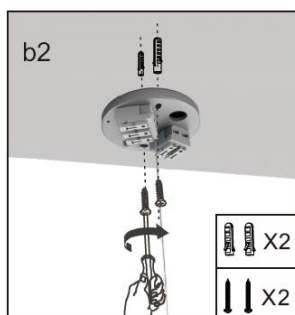
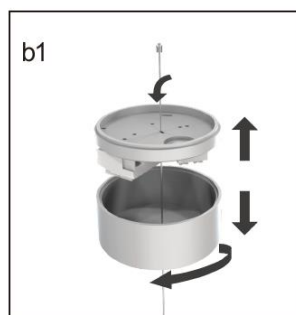
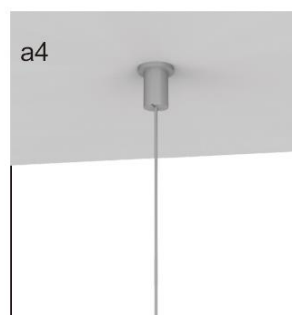
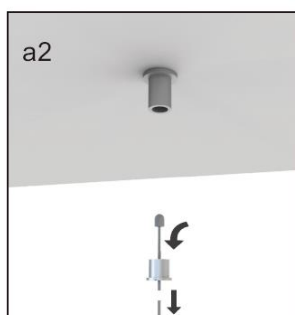
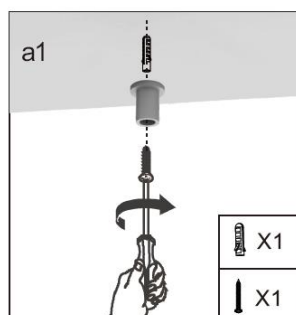

2 - Installation en série / Installatie in serie / Serial installation / Serielle Installation



MAX 10 x



Pour 1 seul cable d'alimentation
for only 1 power cable
voor alleen 1 voedingskabel
für nur 1 Netzkabel

